

# RNJet

Marking & Coding Solutions

RNJET INC.  
26-16 SIMS CRES. RICHMOND HILL, ON  
L4B 2P1, CANADA  
INFO@RNJET.COM  
Tel: 1 (905) 597 4978  
Toll Free: 1 (866) 551 9406

## Hi-Res Piezo Series

RNJet E1-72+ & RNJet E1-140+



RN Mark Inc



RN Mark Inc.

[WWW.RNJET.COM](http://WWW.RNJET.COM)



@rnmarkinc



@rnmarkinc



Valery - Sales Division



## Mission Statement

RnJet Inc is a proudly Canadian purveyor of industrial marking & coding printers. Our skilled team with over 20 years of experience in the industry work hard every day to bring clients top-shelf quality at affordable prices.

We rise above other brands by bringing quality, simplicity, affordability and exceptional customer service to the table; our experienced staff are happy to assist with any issue, no matter how big or small.

“Our machines are designed to be very low maintenance, keeping your operating costs down and your profits up. With RNJet printers, marking and coding your products has never been easier. We offer a wide variety of inks, and our stand-alone controller features a Windows-based interface which is easy to use and has endless capabilities to ensure all your company’s needs are met.

When you purchase an RNJet product, you can count on our uncompromising approach to exceeding expectations and our unmatched customer service.”

Print up to  
144mm in height  
with stitched heads

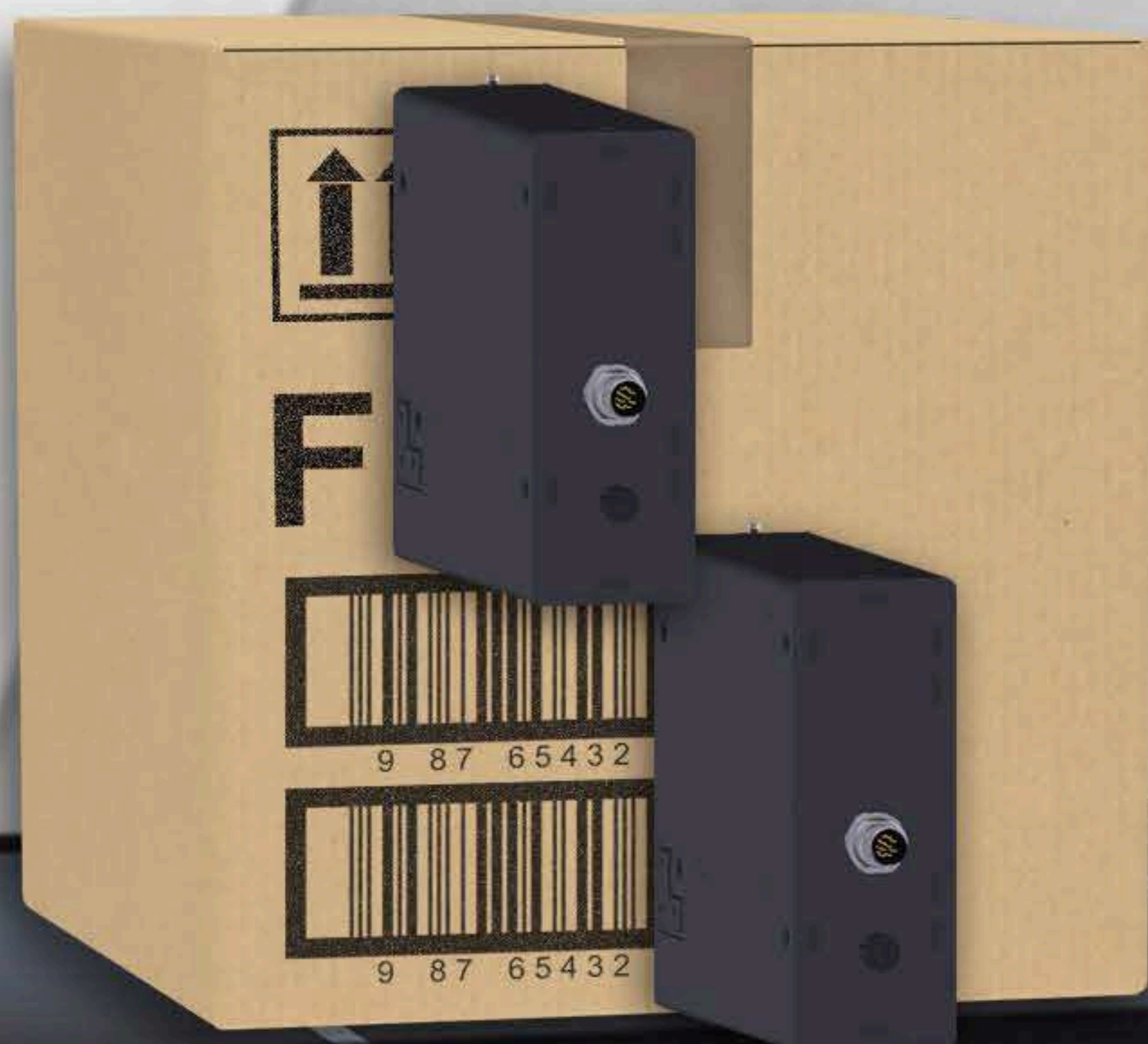

Print up to  
72mm in height  
on two sides,  
simultaneously



Print at a  
downward  
angle



Bi-color  
printing with  
two heads



RNJet is proud to offer the most affordable and high-quality solutions on the market for your production line. It's much easier to buy the full solution, rather than looking for different equipment from various suppliers and trying to make them work together. You can get an all inclusive system: industrial inline hi-resolution inkjet printer and friction feeder from one company. Discover a cost-effective, robust solution that can handle your requirements well into the future, producing clean and legible codes on practically any material, regardless of the environmental temperature and humidity levels.

Motorized Bulk Ink System



Print Head Driver



High Speed,  
User friendly,  
Stand alone LCD  
Controller



\*Cartridge not included

Reliable

Economical

High Speed

Low Maintenance

High Resolution

Canadian Quality

What can you expect from choosing an RNJet machine for your Coding & Marking Solution?

- Creation of high-quality codes, even on high-speed bottling lines
- Consistent code quality and Industry-leading functionality
- Affordable pricing and low cost of ownership
- Easy & swift integration into your production line



# RNJet Printers



With RNJet printers, marking and coding your products has never been more simple, or affordable. Our inkjet print solutions are designed to be seamlessly integrated into your production line; with brackets and photocell included, the machine is ready to go right out of the box.

Our inkjet coders are built with quality components, making the machines highly durable and able to withstand the often harsh conditions of a production line. Print with industry-leading speeds on virtually any surface; uneven or curved facets are no problem for our robust print heads.

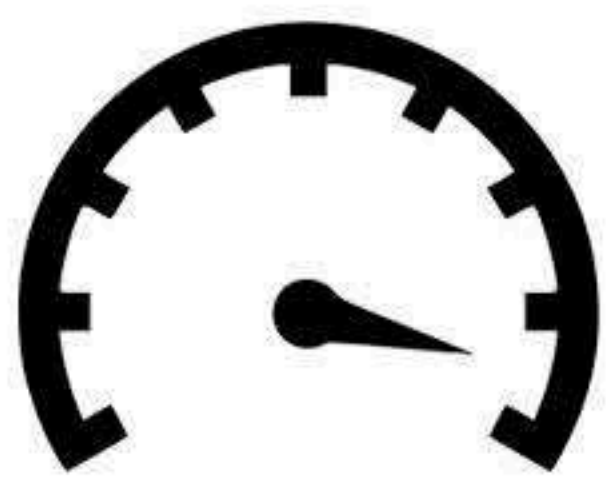

## Print Speed

Our printers have high printing speeds, keeping up with your production line while maintaining superior print quality.



## Canadian Quality

We are a proudly Canadian company; our machines are designed and fully manufactured by our skilled team of technicians in Ontario.

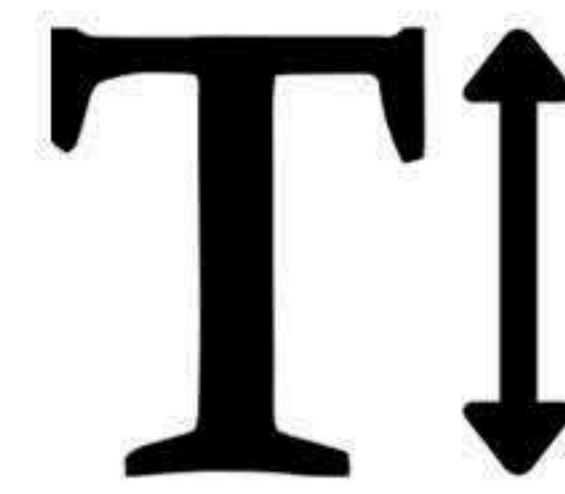

## Print Height

Print a single line at 72mm, or up to 144mm in height using a large character machine with stitched heads.



## Resolution

Our machines maintain top-shelf resolution when printing on practically any material, porous or non-porous.

Our dedicated team works hard to provide the very best industrial inkjet printers with a focus on quality, simplicity, affordability, and exceptional customer satisfaction.

**We offer turn-key automation, control system design and integration, as well as custom mounting to ensure ease of use and integration into your business.**



A question that we often encounter is about print quality on cardboard. This material is porous, absorbent and uneven; a recipe for potentially diminished quality. Our manufacturers have performed a number of comparisons, both in-lab as well as at customer sites, and although print resolution of industrial inkjet printing is lower than print & apply labels, functionality is not affected. Barcodes and QR codes are accurately and reliably scanned but at substantially lower costs. You can trust that our printers will deliver the highest possible quality and we are confident that you will be pleased with the results.

Our Software is User-friendly, the document creation process is as easy as Microsoft Word. Simply create your design and print it in one simple step. RNSoft is a remarkable tool for boosting productivity and reducing costs, it puts a professional labeling and barcode design tool right at your fingertips. Every RNJet printer comes pre-installed with RNSoft, free of charge. No limitation of Users and plenty of languages are available.

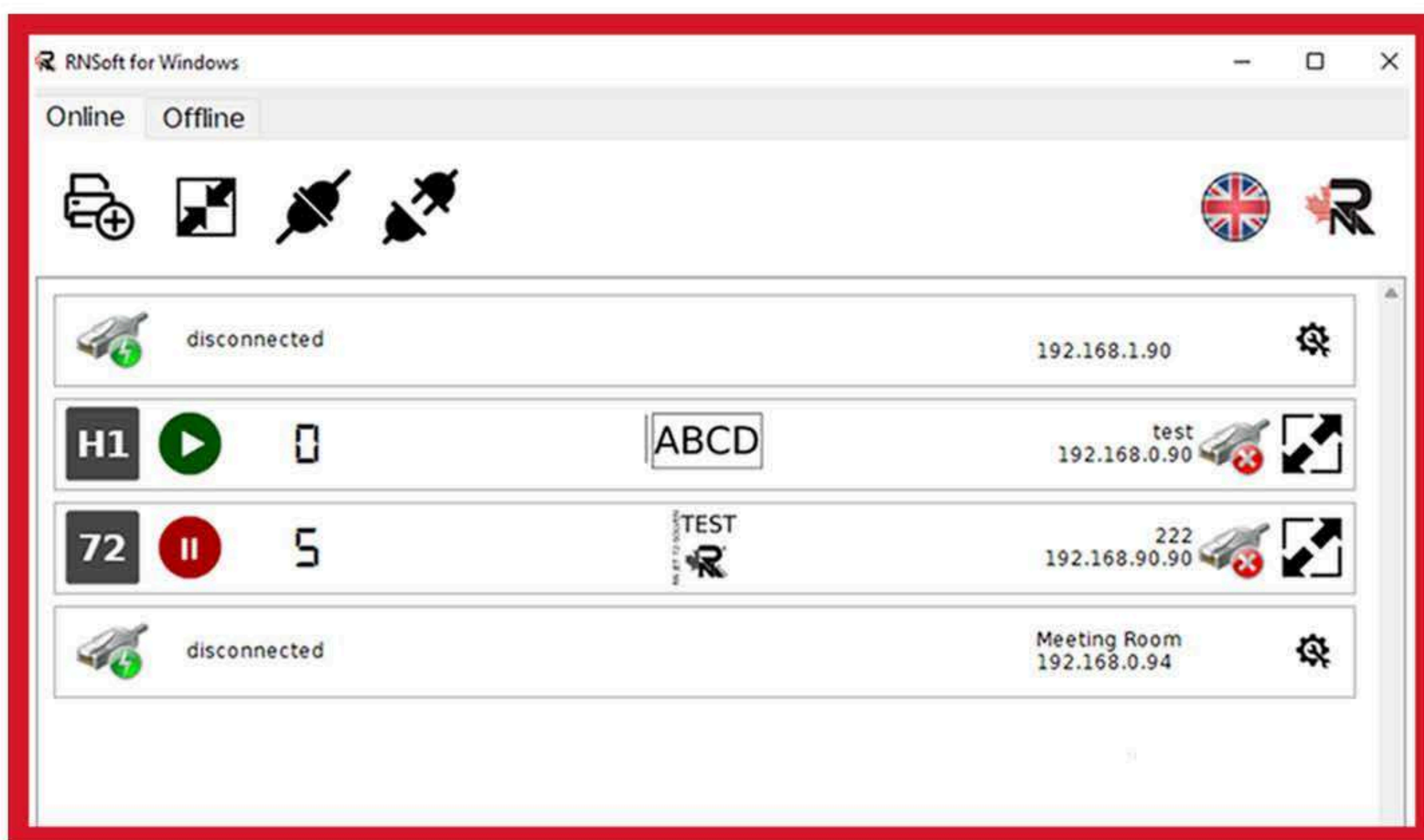

Our specialized Windows-based software comes equipped with a low ink indicator and ink level calculator. When the ink cartridge is inserted, RNSoft measures the remaining ink level via the cartridge chip, and lets you know when it's time to replace. This allows for close monitoring of each individual color and cartridge, never missing a print.

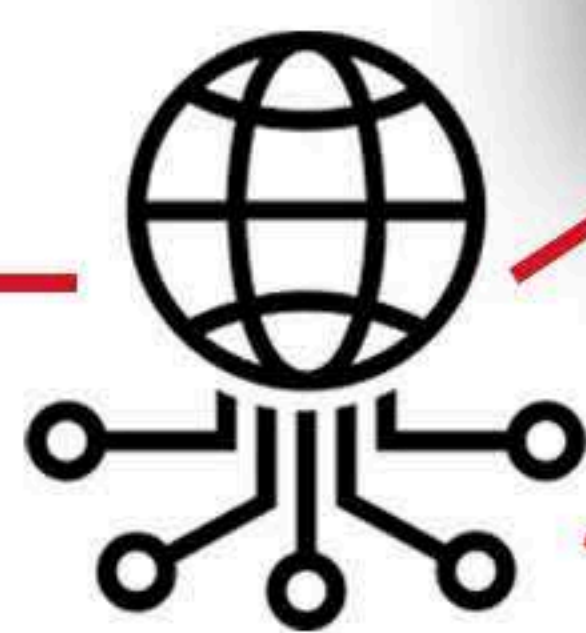

RNSoft allows up to 100 printers to be connected simultaneously to one PC through your network.

Want color options? RNJet's got you covered!

Our machines are capable of printing on any piece you need marked. With RNJet's industrial inkjet printers, you can perform non-contact printing not only with black ink, but also pigmented white and pigmented yellow, red, and blue.



# Printable Data

# RNJet

Each printer comes pre-loaded with our Windows based software, free of charge. This user-friendly software is capable of printing the following data on practically any surface you need:

- Static text
- Auto date & time
- Julian date
- Jalali date
- Auto manufacture date
- Auto expiry date
- Batch number
- Serial number
- Auto shift codes
- Logo
- Image
- QR code
- GS1 Data Matrix
- UDI
- Database
- Counter
- External text  
(weight & other info from scale and barcode scanner)

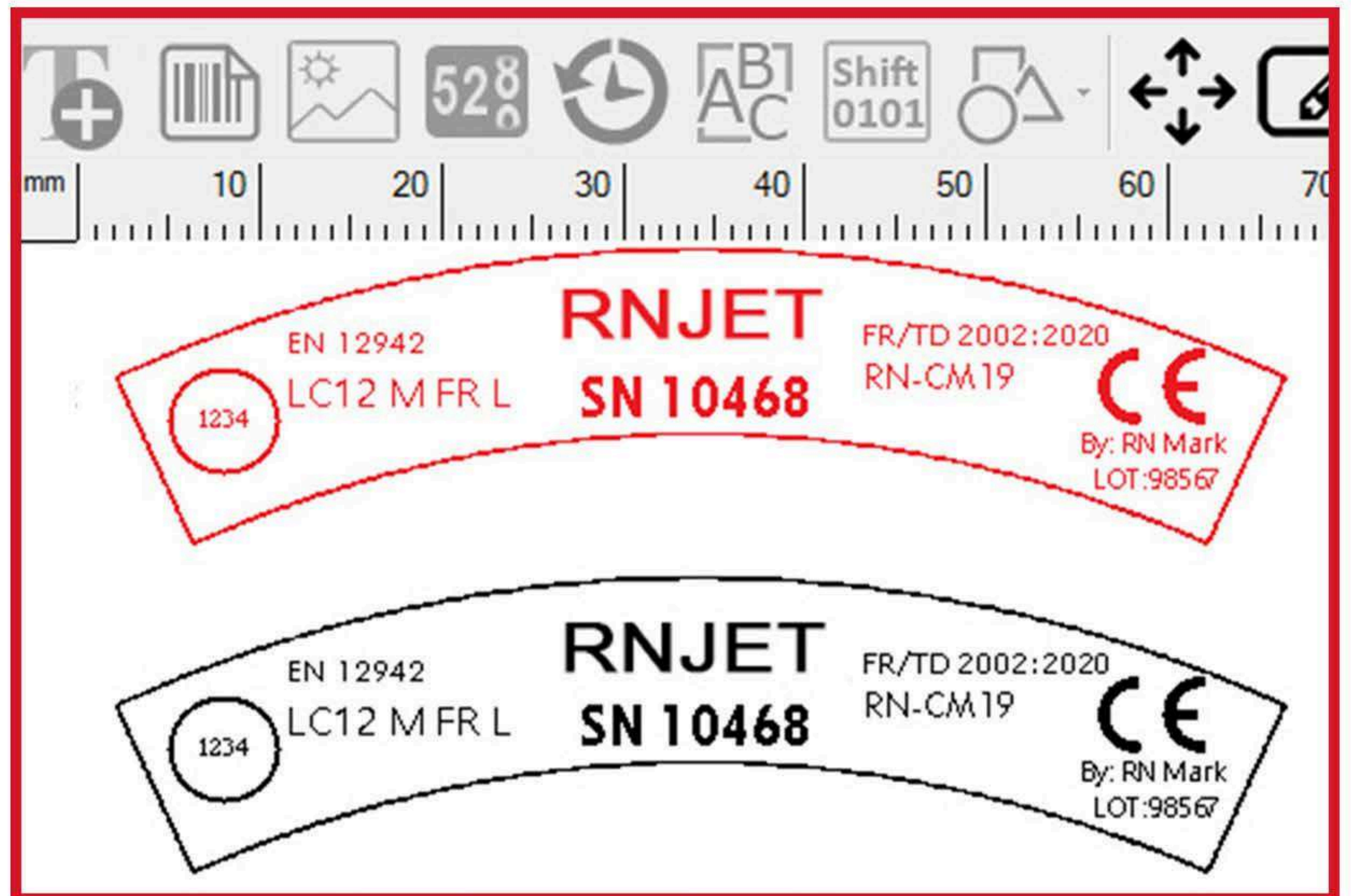

Our 7" Touchscreen LCD controller is made from stainless steel. This robust piece of machinery is dust and droplet resistant, and has no problem handling the often harsh conditions of a production line.



Printing & marking legible and accurate information on products is an important requirement for any manufacturer. RNJet provides industrial inkjet printers for printing Logos, Julian Dates, ISPM Marking, IPPC Certification symbols, Country of Origin, any type of barcodes, serial numbers, etc. in a wide variety of languages. Specially designed printing solutions for marking your products will keep your production going with no downtime, and ensure clear, legible prints every time.

# Print Samples

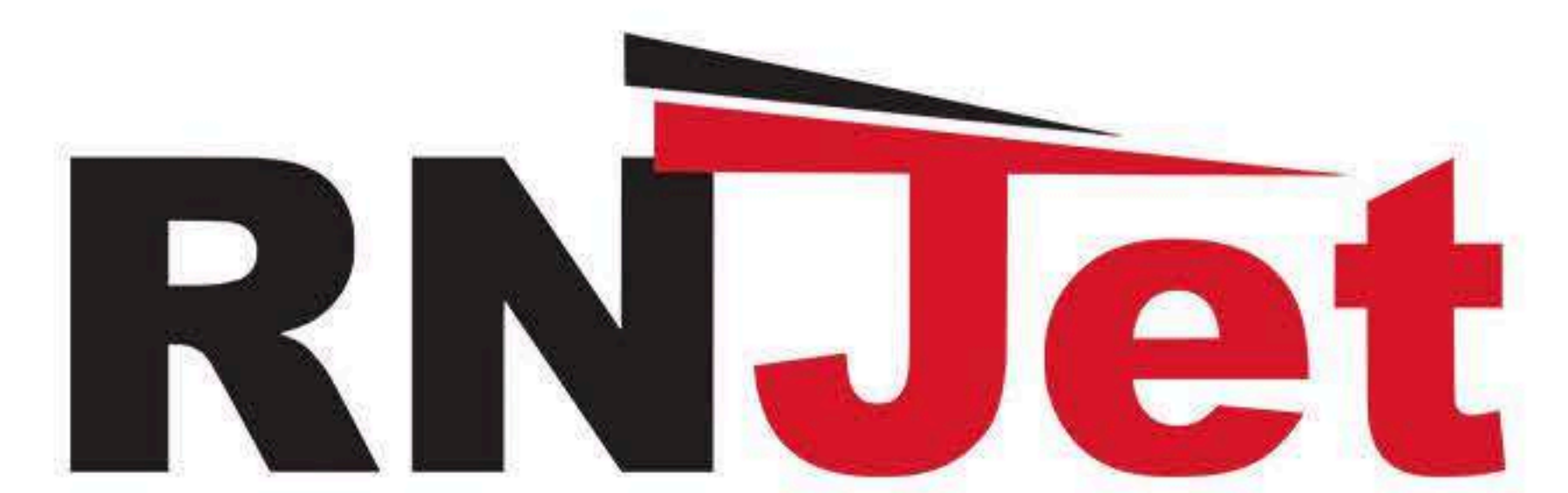

We are experts in the marking & coding requirements of Food & Beverages, Breweries, Cables & Pipes, Extrusion lines, Cosmetic & Personal Care, Dairy, Egg Production, Pet Food Lines, Electronic Components, Cardboard & Carton Printing, Face Respirators, PPE & Mask Production, Hand Sanitizers, Pallets and Wood Products and many more industries. RNJet printers ensure legible, accurate prints every time, so you are always complying with the marking and coding regulations of your industry.

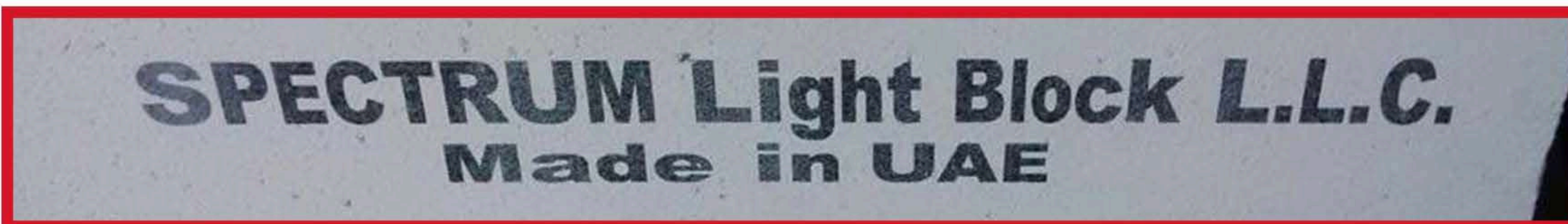
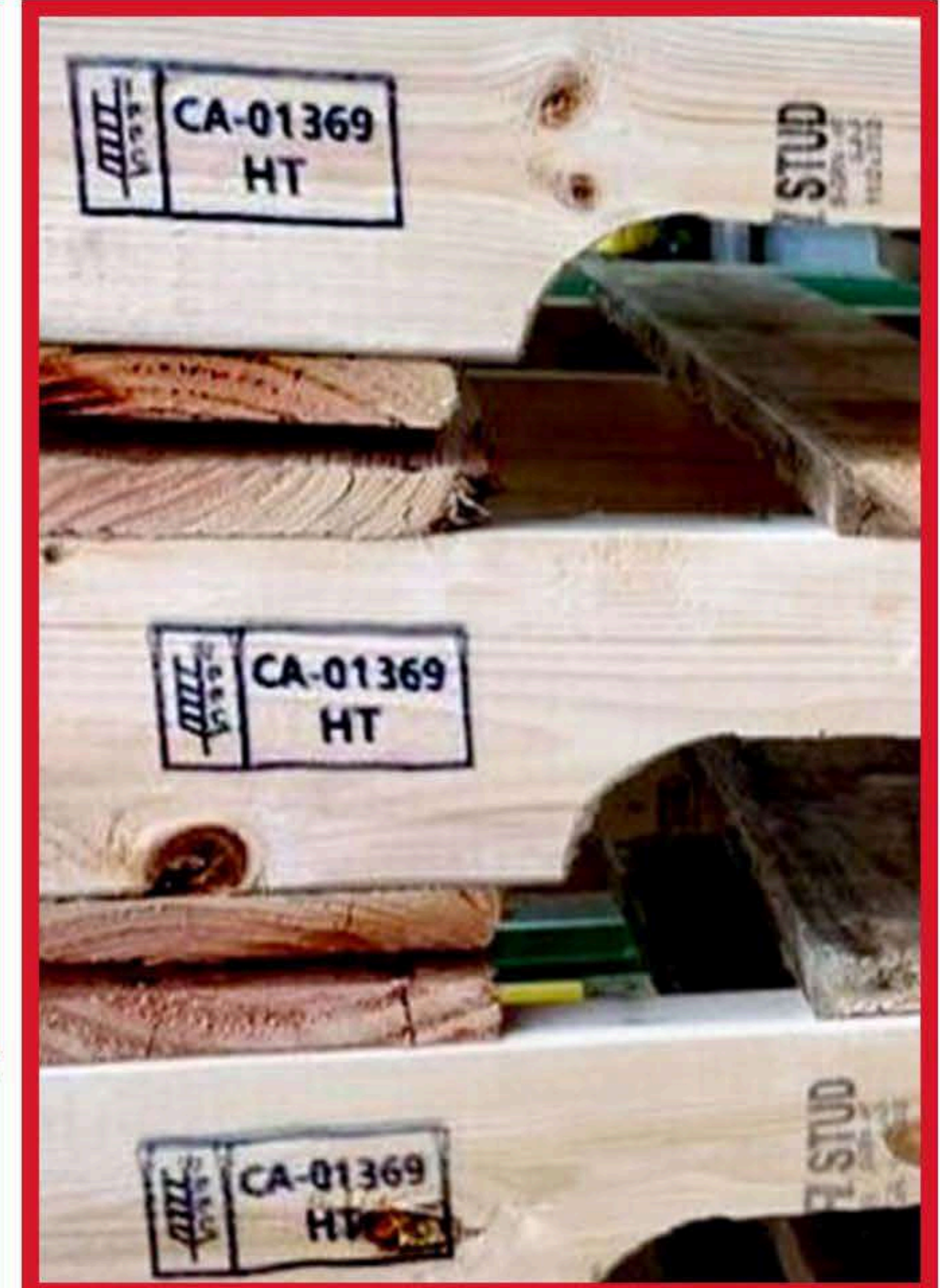

With RNJet's inline solutions, it's easy and cost-effective to mark your product, whether it's metal or fiberglass material, plastic or cloth, pleated paper or PET recyclable plastic!

Consult with our specialist to get the right solution for your production line.

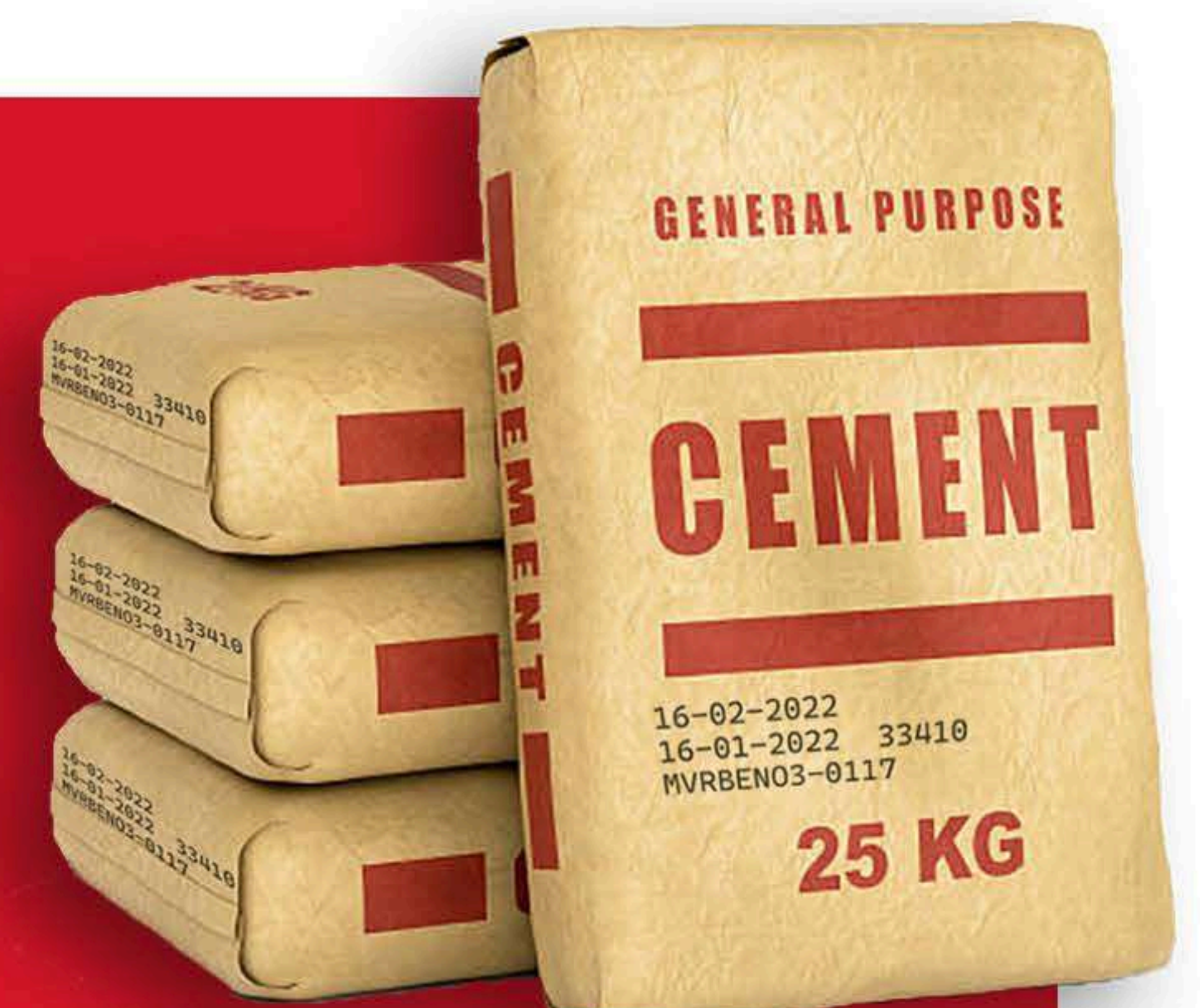

# Specifications



Specifications	RNJet E1-72+	RNJet E1-140+
Display	7" touchscreen LCD controller	
No. of Print Heads	1	2
Printing Speed	up to 60m/min (180 dpi) or up to 90m/min (120 dpi)	up to 60m/min (180 dpi) or up to 90m/min (120 dpi)
Max. Print Height	up to 72mm	up to 144mm
Printing Distance	up to 15mm	up to 15mm
Printing Orientation	Side printing, downwards, at an angle	
Min. Drying Time for non-porous material	10 to 15 seconds, depending on material	10 to 15 seconds, depending on material
Ink Color	Black, Red	Black, Red
Ink Management	Ink calculator on controller, low ink LED indicator, output for optional ink beacon alarm	Ink calculator on controller, low ink LED indicator, output for optional ink beacon alarm
Ink System	Motorized bulk ink system (490 ML Bottle)	Motorized bulk ink system (490 ML Bottle)
Ink Types	Solvent-based, oil-based and food-grade	Solvent-based, oil-based and food-grade
Max. Printing Length	up to 4600mm	up to 2300mm
Print Modes	Single & Continuous	
Supported Database Format	CSV, TXT	
Message Library	More than 1000 messages	
Interface & Keyboard Languages	English, French, Spanish, Italian, Portuguese, Russian, Arabic, Farsi, and many more	
Software	RNSoftPlus for controller, and RNSoftPlus for Windows included for free with every printer	
I/O Ports	Photocell, Shaft Encoder, Ethernet, RS-232, USB, RS 485, beacon alarm	
Operating Conditions	Temp: 0°C - 45°C Relative Humidity: 20%-80%	Temp: 0°C - 45°C Relative Humidity: 20%-80%
External Power	Input : 100-240V 50/60 Hz. Output : 12v-5.0A, 60W Max	Input : 100-240V 50/60 Hz. Output : 12v-5.0A, 60W Max

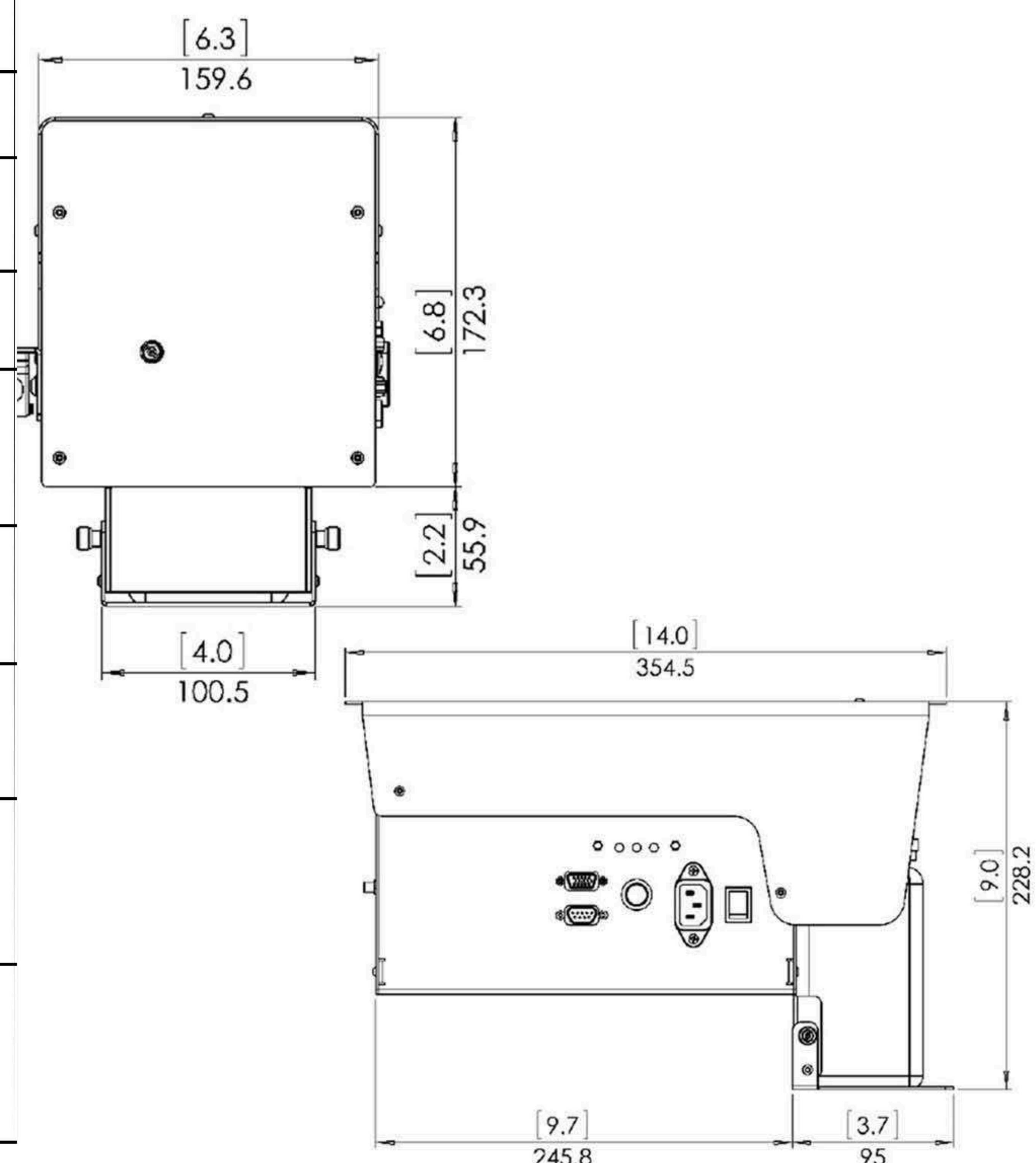
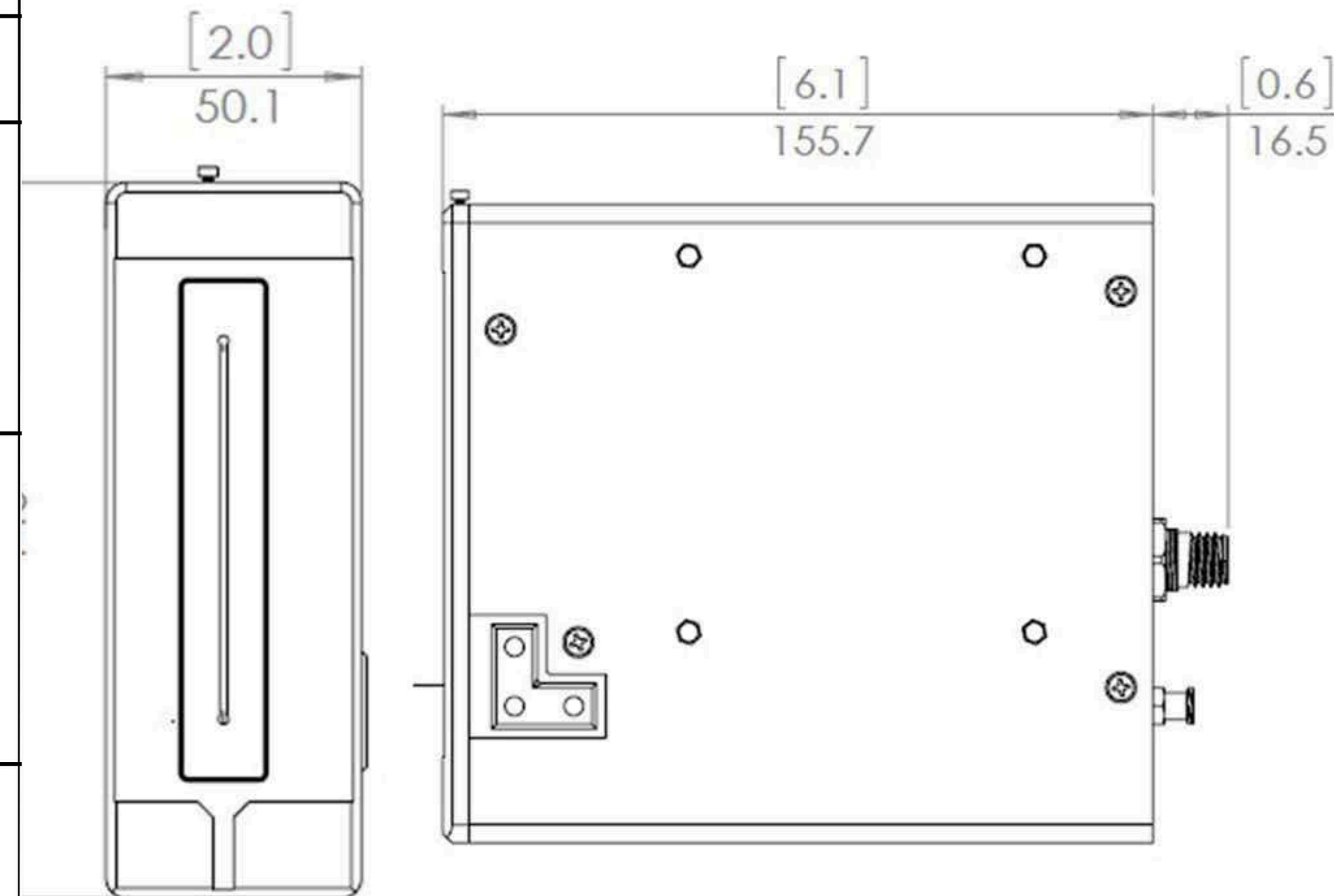
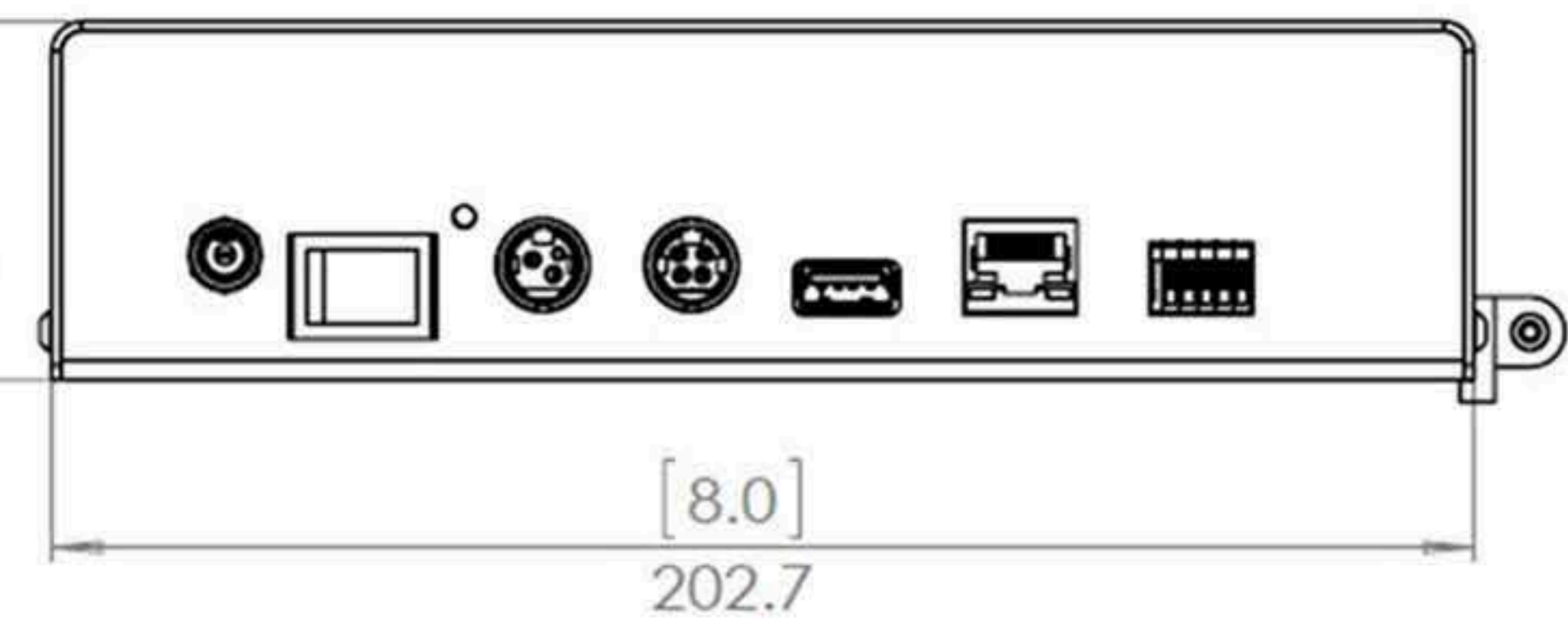
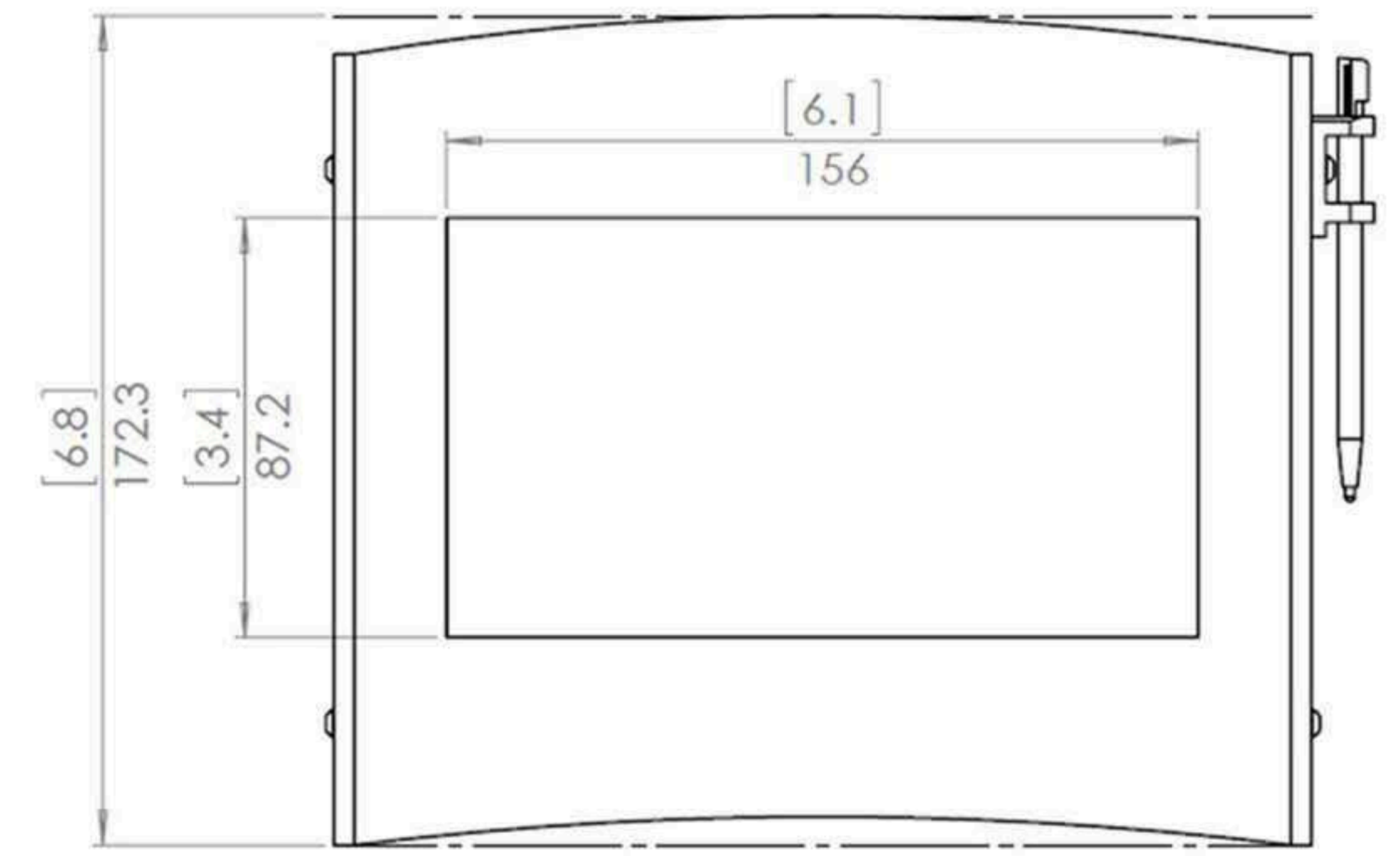

Dimensions are in mm [inch]

# Software Abilities

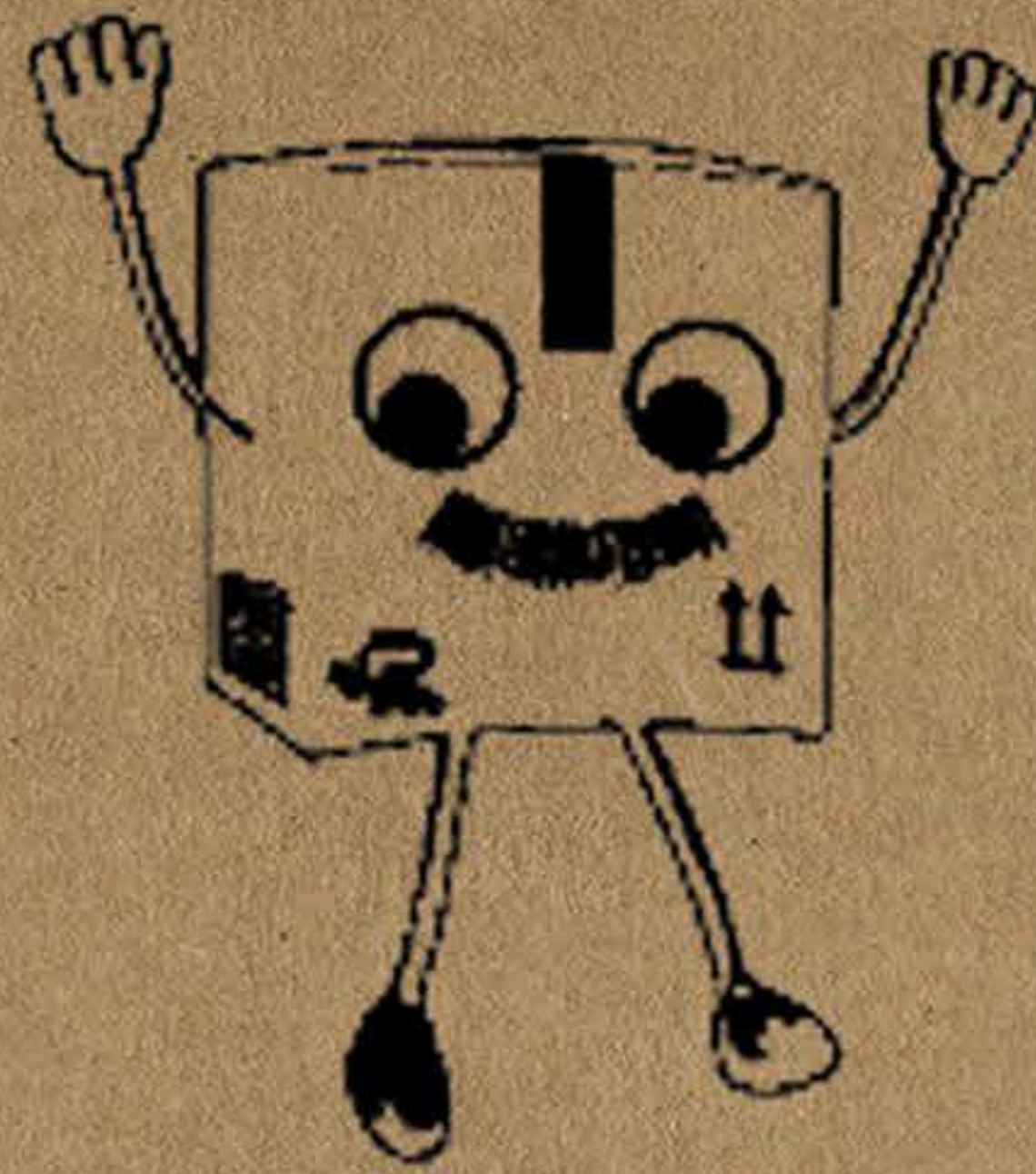
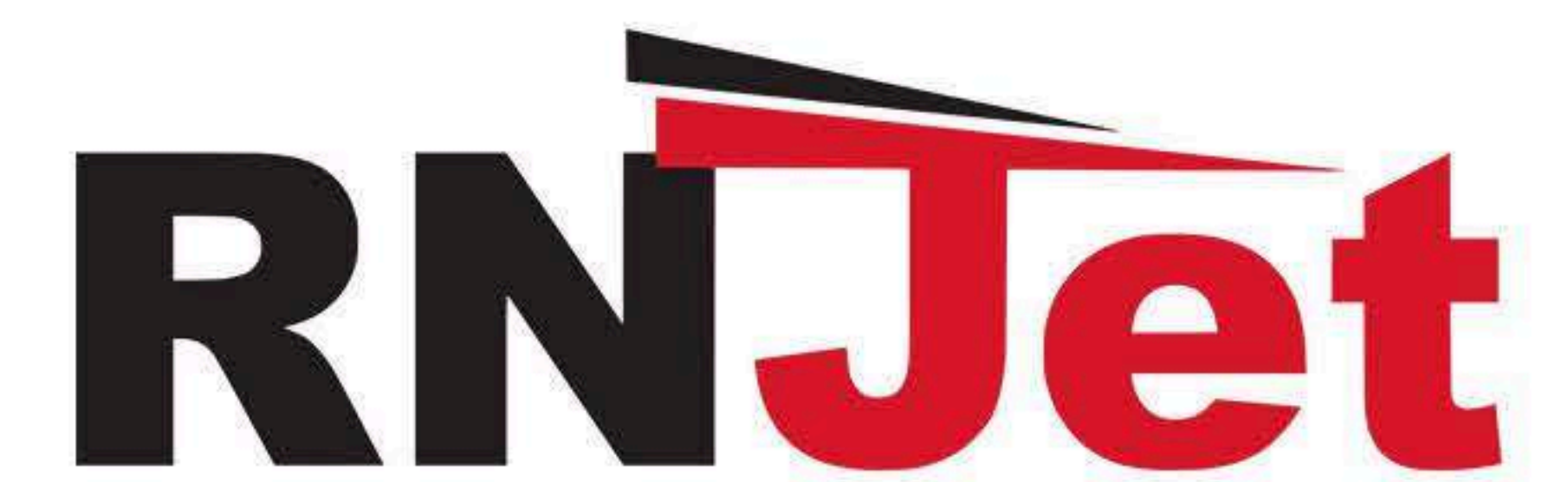









00001  
13:01

LOT #: 5682532  
MFG: 22-04-12  
EXP: 24-04-12

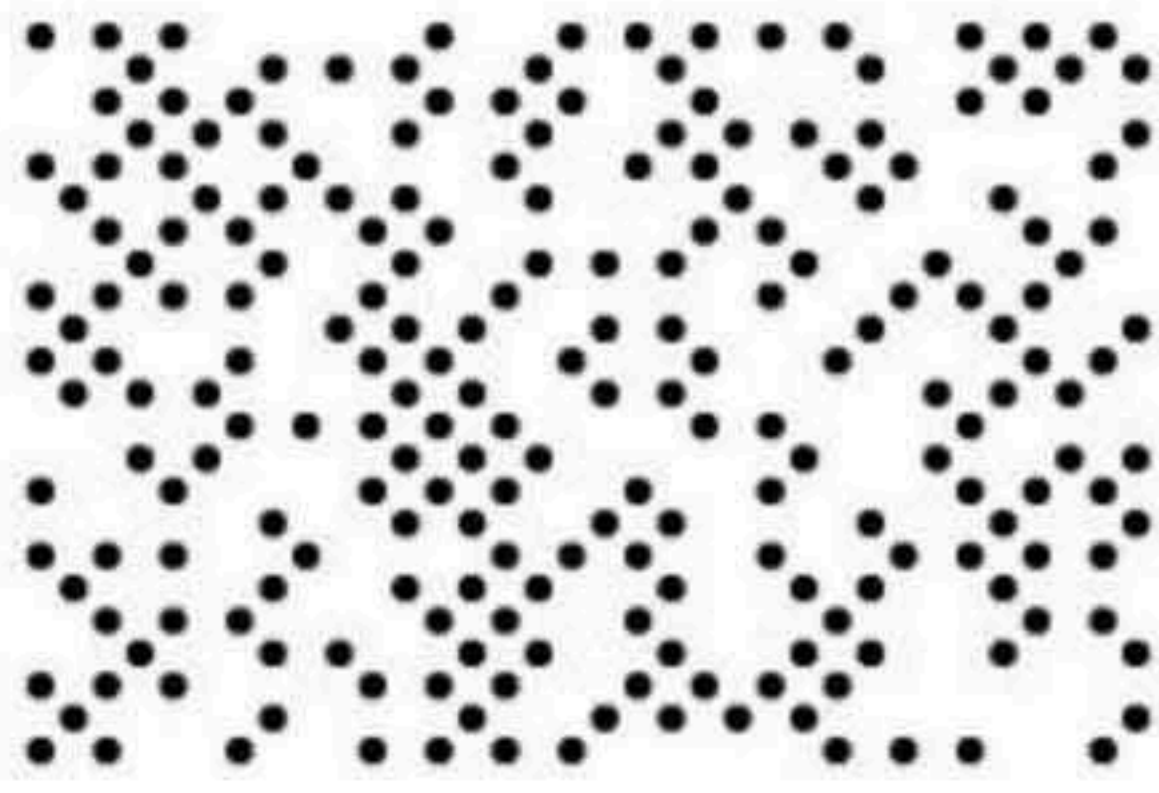

MADE IN CANADA

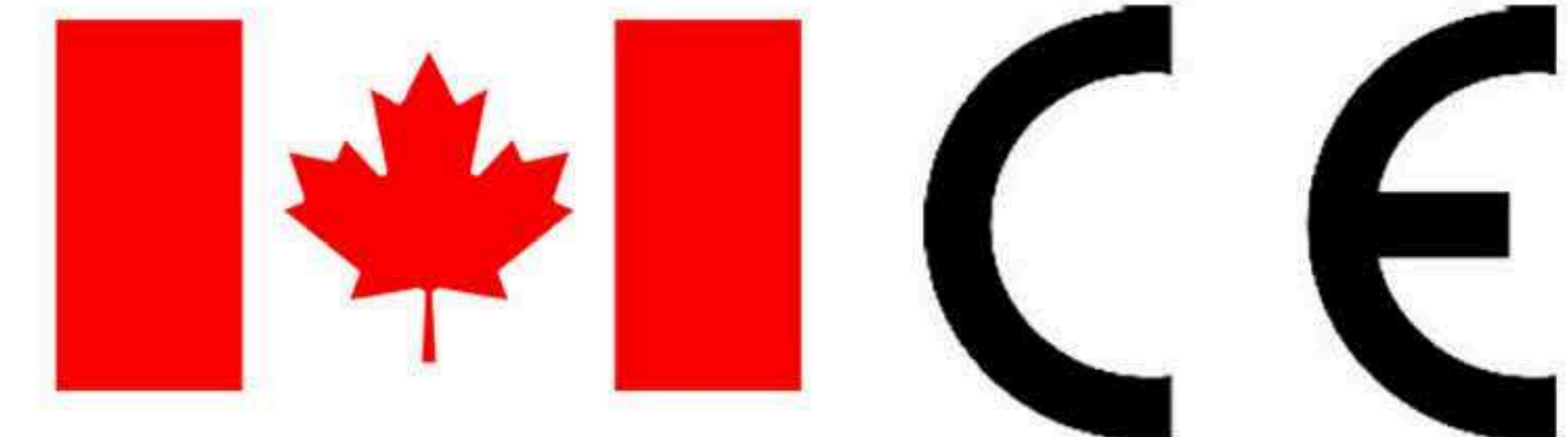

Description	Print Samples			
<p><b>Linear Bar Codes</b> (EAN, ITF-14, UPCA, GS1 Databar, and many more)</p>	 (01)01013568089768	 2 20 10172 38968 3	 2 20101 47521 1	
<p><b>2D Codes</b> (QR, GS1 DataMatrix Standard, Dot Code, GS1 Databar-Stacked &amp; Limited, MicroPDF and many more)</p>				
<p><b>Logos &amp; Graphics</b> (Print any image, logo, graphic or icon with Dither or negative)</p>				
<p><b>Specialty Fonts</b> (Download any TTF Fonts such as Arial, Dot Font, and many more)</p>	<p> <b>RNJet</b> <i>RNJet</i> WELCOME!  <b>RNJet</b> <i>RNJET</i> Bonne après-midi  <b>RNJet</b> <i>RNJET</i> Bienvenido         </p> <p>           ДОБРО ПОЖАЛОВАТЬ            خوش آمدید            أهلا بك         </p>			

Print any barcode, image, graphic, or font at any rotation with our user-friendly design software.

# RNJet E1-72+

72  
mm

## High Resolution

Print up to 72mm in height

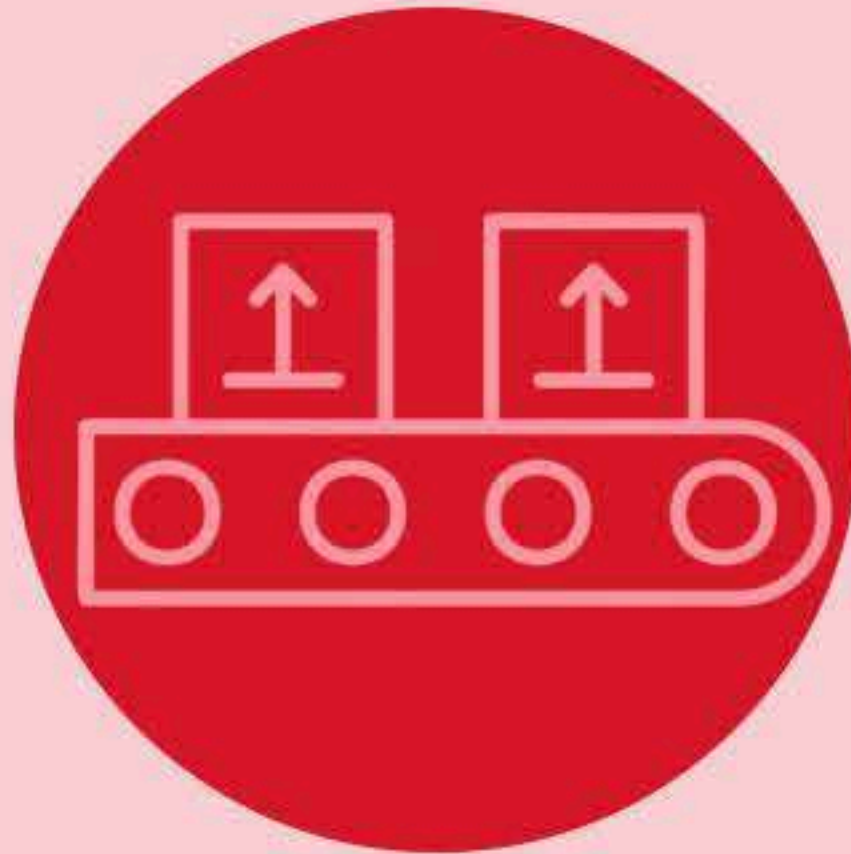

## Stand-Alone Printing

Easily integrated into any production line



## Logos, Graphics and Barcodes

Import JPG, BMP, and PNG files. Create 1D, 2D and QR codes.

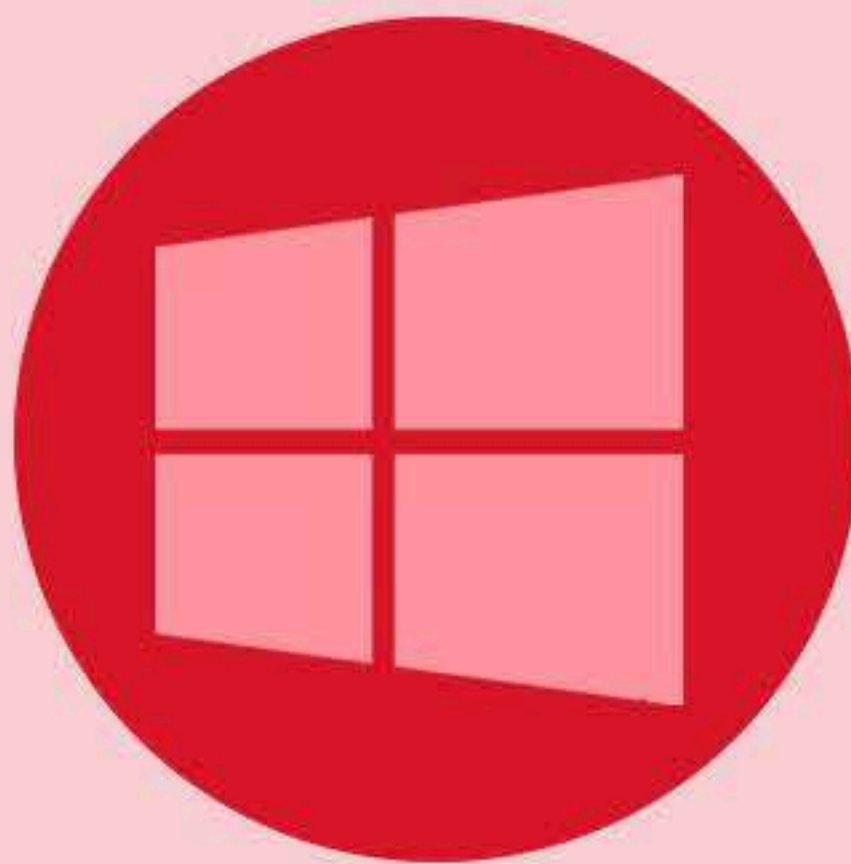

## RN Soft

Windows-Based Software

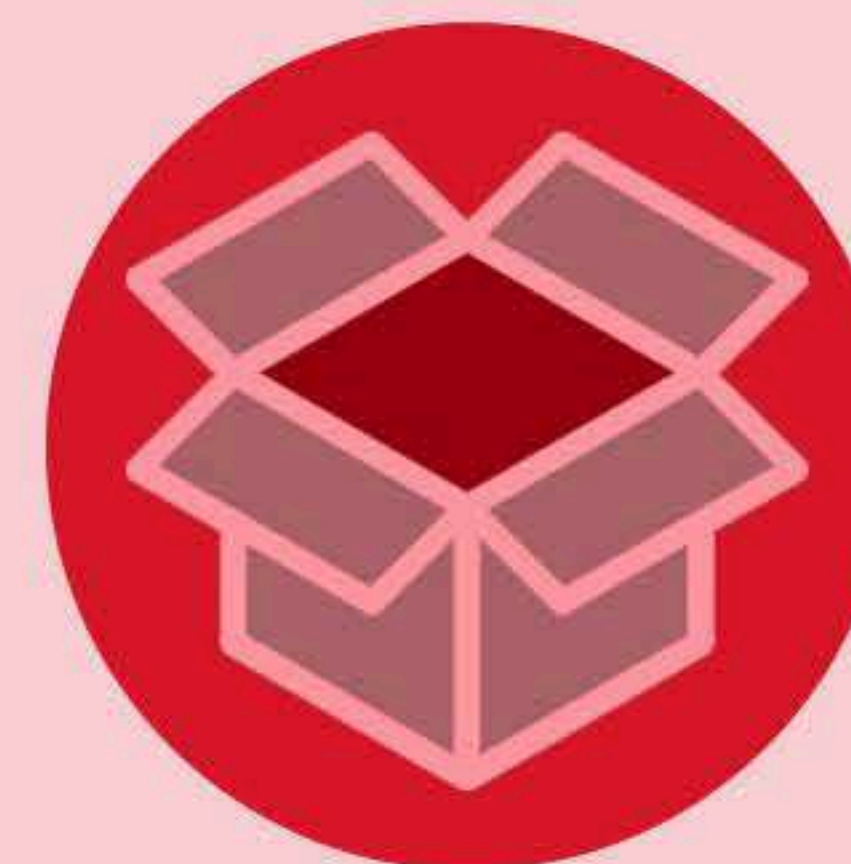

## Out of the Box Installation

Low maintenance and compact, includes brackets for production line installation



## All True Type Fonts & Symbols

Create messages in any language



# RNJet E1-140+

144  
mm

## High Resolution

Print up to 144mm in height

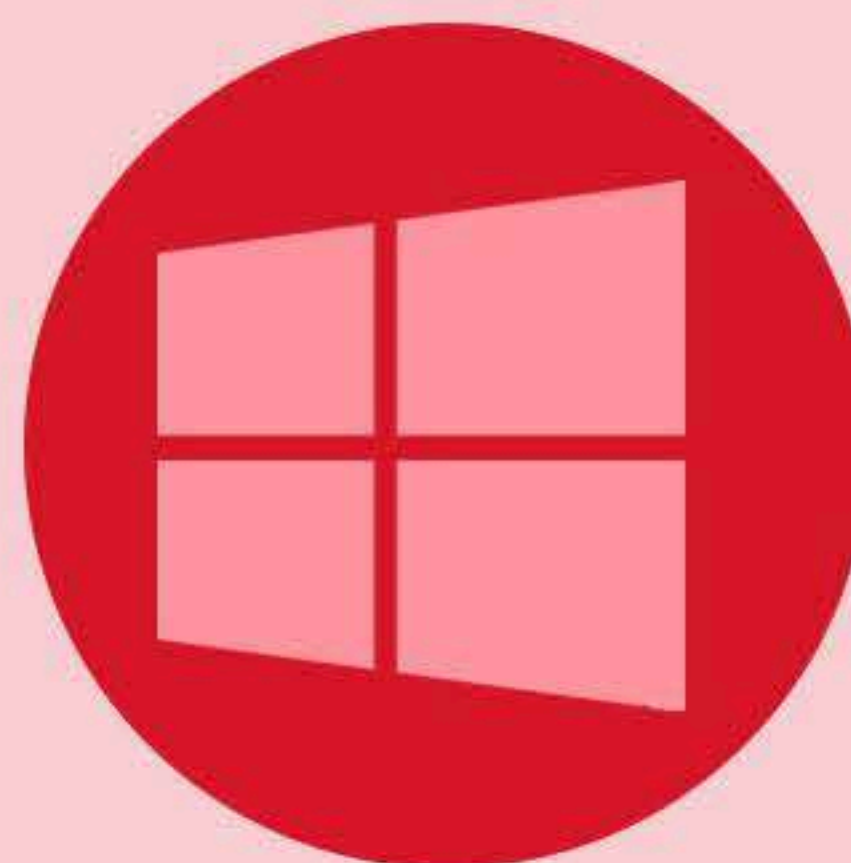

## RN Soft

Windows-Based Software



## All True Type Fonts & Symbols

Create messages in any language

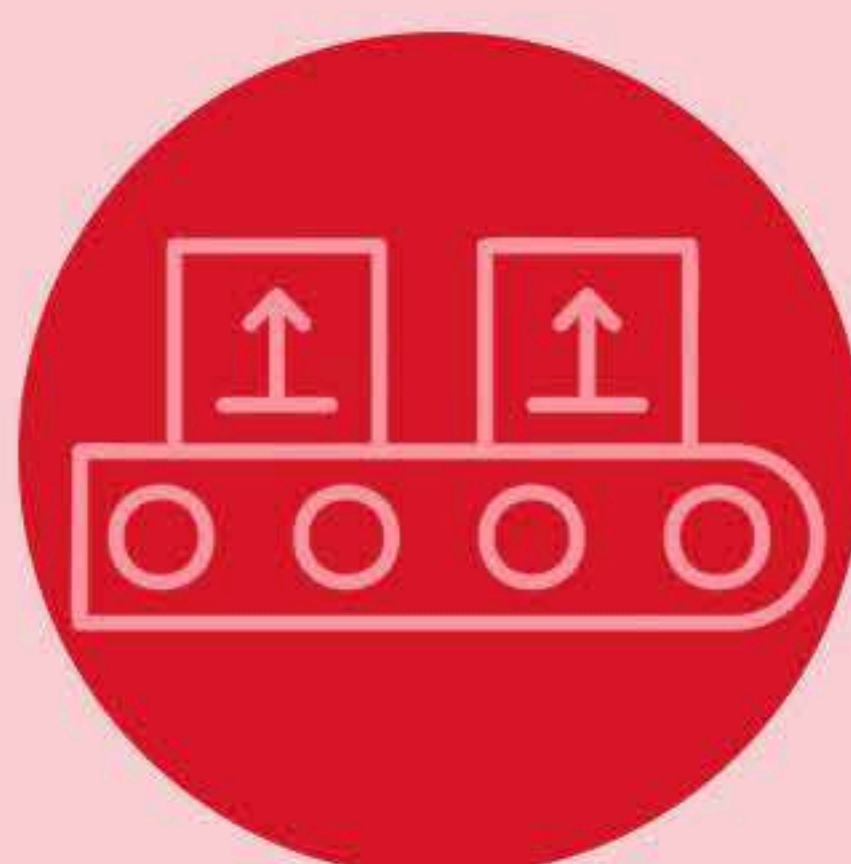

## Stand-Alone Printing

Easily integrated into any production line

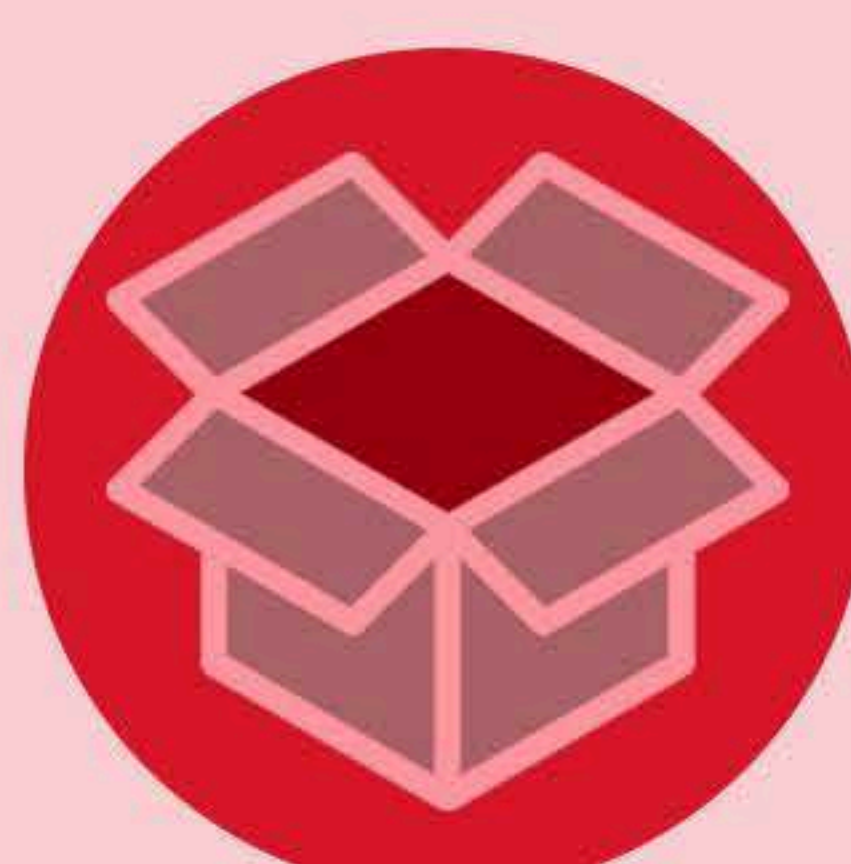

## Out of the Box Installation

Low maintenance and compact, includes brackets for production line installation



## Logos, Graphics and Barcodes

Import JPG, BMP, and PNG files. Create 1D, 2D and QR codes

